

Data Sheet | Item Number: 2273-208

Conector de îmbinare PUSH WIRE®; pentru conductori unifilari; max. 2,5 mm²; 8 conductori; carcasă transparentă; capac gri deschis; Temperatură aer ambiant: max 60°C (T60); 2,50 mm²; transparent

<https://www.wago.com/2273-208>



Color: transparent

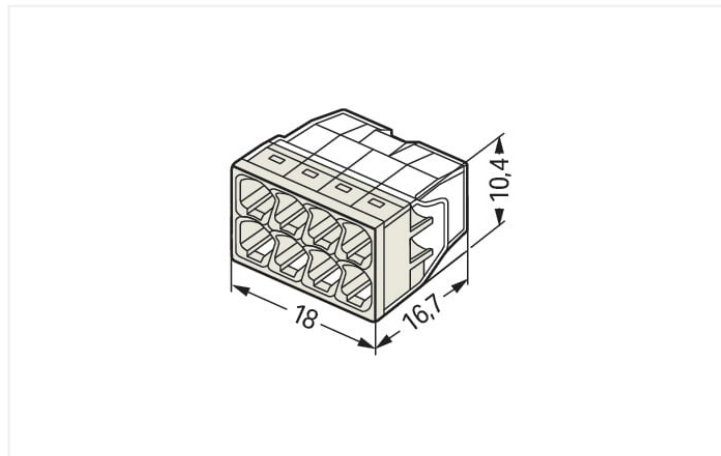

Dimensions in mm

Advantages:

- Convenient wiring via extremely compact design
- Push-in termination of up to eight solid conductors
- Cross-section range: 0.5 ... 2.5 mm²
- Any combination of conductor sizes is possible
- PUSH WIRE® connection terminates solid ("s") copper conductors

Notes

Safety management note

NOTICE: Observe installation and safety instructions!

- **Only to be used by electricians!**
- Do not work under voltage/load!
- Use only for proper use!
- Observe national regulations/standards/guidelines!
- Observe technical specifications for the products!
- Observe the number of permissible potentials!
- Do not use damaged/dirty components!
- Observe conductor types, cross-sections and strip lengths!
- Insert conductor until it hits the product's backstop!
- Use original accessories!

To be sold only with installation instructions!

Safety Information

in grounded power lines

Electrical data

Ratings per	IEC/EN 60998		
Overtoltage category	III	III	II
Pollution degree	3	2	2
Nominal voltage	-	-	450 V
Rated surge voltage	-	-	4 kV
Rated current	-	-	24 A

Approvals per	UL 486C		
Use group	B	C	D
Rated voltage	-	-	-
Rated current	-	-	-

Connection data

Clamping units	8	Connection 1	
Total number of potentials	1	Connection technology	PUSH WIRE®
		Actuation type	Push-in
		Connectable conductor materials	Copper Aluminum
		Connectable conductor materials (note)	<p>Terminating Aluminum Conductors WAGO spring clamp terminal blocks are suitable for solid aluminum conductors up to 4 mm²/12 AWG if WAGO "Alu-Plus" Contact Paste 249-130 is used for termination.</p> <p>"Alu-Plus" Contact Paste Advantages:</p> <ul style="list-style-type: none"> • Automatically destroys the oxide film during clamping. • Prevents fresh oxidation at the clamping point. • Prevents electrolytic corrosion between aluminum and copper conductors (in the same terminal block). • Provides long-term protection against corrosion. <p>For spring clamp connections with PUSH WIRE® connection technology, WAGO recommends that the aluminum conductor first be cleaned and then immediately inserted into the clamping unit filled with "Alu-Plus" contact paste.</p> <p>It is also possible to apply WAGO "Alu-Plus" additionally on the whole surface of the aluminum conductor before termination.</p> <p>Please note that the nominal currents must be adapted to the reduced conductivity of the aluminum conductors:: 2.5 mm² = 16 A 4 mm² = 22 A</p>
		Solid conductor	0,5 ... 2,5 mm ² / 20 ... 16 AWG
		Strip length	11 mm / 0.43 inci
		Wiring direction	Side-entry wiring

Physical data

Width	18 mm / 0.709 inci
Height	10,4 mm / 0.409 inci
Depth	16,7 mm / 0.657 inci

Material data

Note (material data)	Information on material specifications can be found here
Color	transparent
Cover color	light gray
Material group	IIIa
Insulation material (main housing)	Polycarbonate (PC)
Flammability class per UL94	V2
Clamping spring material	Chrome-nickel spring steel (CrNi)
Contact material	Electrolytic copper (E _{Cu})
Contact Plating	Tin
Fire load	0.046 MJ
Weight	2.2 g

Environmental requirements

Ambient temperature (operation)	+60 °C
Continuous operating temperature	105 °C
Temperature marking per EN 60998	T60

Commercial data

Product Group	7 (Push Wire Conn.)
eCl@ss 10.0	27-14-11-04
eCl@ss 9.0	27-14-11-04
ETIM 8.0	EC000446
ETIM 7.0	EC000446
PU (SPU)	500 (50) Buc.
Packaging type	Box
Country of origin	DE
GTIN	4050821027881
Customs tariff number	85369010000

Environmental Product Compliance

RoHS Compliance Status	Compliant, No Exemption
------------------------	-------------------------

Approvals / Certificates

General approvals



Approval	Standard	Certificate Name
cULus_Listed_667F Underwriters Laboratories Inc.	UL 486C	E69654
VDE VDE Prüf- und Zertifizie- rungsinstitut	EN 60998	40029794

Declarations of conformity and manufacturer's declarations

Approval	Standard	Certificate Name
EU-Declaration of Confor- mity WAGO GmbH & Co. KG	-	-
UK-Declaration of Confor- mity WAGO GmbH & Co. KG	-	-

Approvals for marine applications



Approval	Standard	Certificate Name
ABS American Bureau of Ship- ping	-	15-HG1419918-PDA
DNV GL Det Norske Veritas, Ger- manischer Lloyd	EN 60998	TAE000015T
LR Lloyds Register	EN 60998	LR22207029TA

Downloads



Environmental Product Compliance

Compliance Search





Environmental Product
Compliance 2273-208

Documentation

Bid Text

2273-208	19.02.2019	xml 3.18 KB	
2273-208	17.05.2017	doc 24.50 KB	
ausschreiben.de 2273-208			

CAD/CAE-Data

CAD data	CAE data
2D/3D Models 2273-208	EPLAN Data Portal 2273-208
	
	WSCAD Universe 2273-208
	
	ZUKEN Portal 2273-208
	

1 Compatible Products

1.1 Optional Accessories

1.1.1 General accessories

1.1.1.1 Moisture protection

[Item No.: 207-1331](#)Gelbox; Derivație; pentru cabluri; cu gel;
Seriile 221, 2x73; conectori de max. 4
mm²; fără conectori pentru cutia de jon-
cțiune; Mărimea 1; gri[Item No.: 207-1332](#)Gelbox; Derivație; pentru cabluri; cu gel;
Seriile 221, 2x73; conectori de max. 4
mm²; fără conectori pentru cutia de jon-
cțiune; Mărimea 2; gri[Item No.: 207-1333](#)Gelbox; Derivație; pentru cabluri; cu gel;
Seriile 221, 2x73; conectori de max. 4
mm²; fără conectori pentru cutia de jon-
cțiune; Mărimea 3; gri

1.1.2 Mounting adapter

1.1.2.1 Mounting accessories



Item No.: 2273-500

Suport de montaj; pentru con. cu una și două linii; Seria 2273; pt mont. pe șină DIN 35/montare cu șurub; portocaliu

1.1.3 Tool

1.1.3.1 "Alu-Plus" contact paste



Item No.: 249-130

Seringă; Conținut: 20 ml de pastă de contact „Alu-Plus”

Installation Notes

Conductor termination



Strip solid conductor to 11 mm/0.43 inch (see marking).



The transparent housing shows if conductors are fully inserted; within the colored base, a clear port shows if the conductor's strip length is correct. Conductors are correctly stripped if the clear port shows no bare conductor on the unprinted connector side. Picture shows center conductor with exceeded strip length.

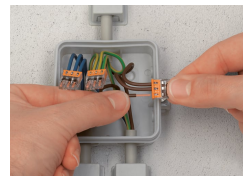

Termination: Insert the stripped solid conductor until it hits the backstop.



Removal: Hold conductor to be removed and twist alternately left and right while pulling the connector.

Testing



Testing via test port opposite to conductor entry.